

# LINE CONDITIONERS

AVR VOLTAGE STABILIZERS  
GALVANIC SEPARATORS

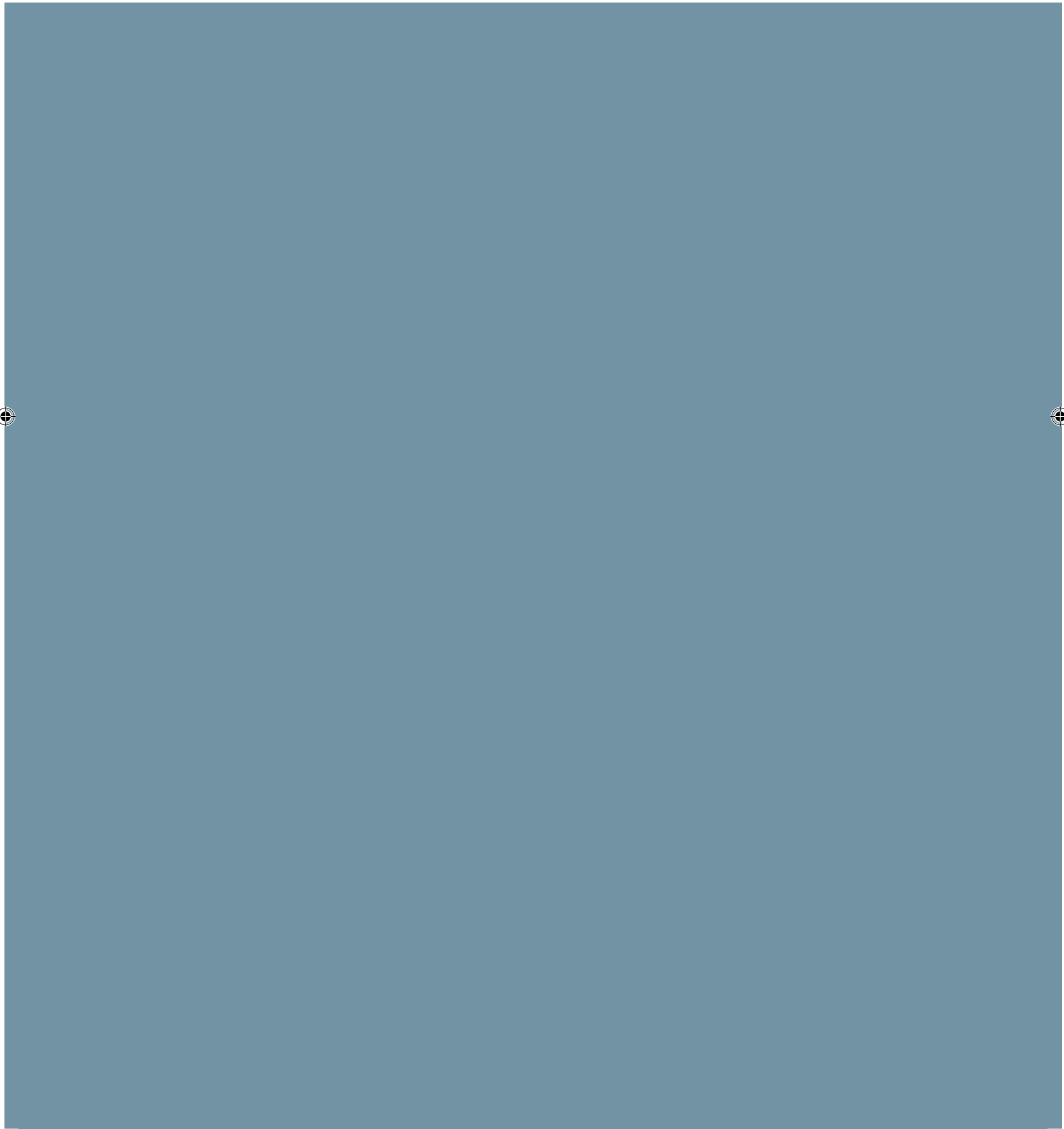

EDIZIONE 2023  
2023 EDITION





## TRASFORMATORI DI ISOLAMENTO

### *GALVANIC SEPARATORS*

TSR	4
-----	---

TSR DIN BAR	5
-------------	---

## STABILIZZATORI DI TENSIONE 1PH

### *1PH STABILIZERS AVR*

ESTAB	6-7
-------	-----

## CONDIZIONATORI DI RETE 1PH

### *1PH LINE CONDITIONERS*

ESTAB-S	8-9
---------	-----

## STABILIZZATORI DI TENSIONE 3PH+N

### *3PH+N STABILIZERS*

3 ESTAB	10-11
---------	-------

BST	12-13
-----	-------

## ALTRI PRODOTTI

### *OTHER PRODUCTS*

U.P.S. NO BREAK	14
-----------------	----



# TSR



## TRASFORMATORI SEPARATORI GALVANICI DI RETE GALVANIC SEPARATORS SAFETY TRANSFORMERS

Made in Italy



TSR 1000

- Protezione contro caduta fulmini
- Sicurezza operatori ed elettromedicali
- Filtro antidisturbo

- Lightning damage protection
- Medical equipments safety
- E.M.C. noise limiters

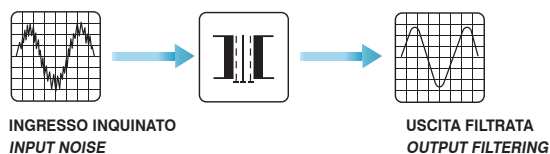

Efficienti e sicuri trasformatori ad **alto isolamento con schermo elettrostatico filtro transistori**. Elevata protezione caduta fulmini e filtraggio disturbi in rete. Lo schermo elettrostatico blocca e impedisce il transito di tutte le pericolose e dannose extra tensioni presenti in rete.

**Dotazioni:** contenitore chiuso e conforme alle norme vigenti, interruttore di accensione, morsettiera protetta, innovativo display LCD per la visualizzazione della potenza al carico e tensione di rete.

**Applicazioni:** elettromedicali, apparati con possibilità di dispersione elettrica, laboratori di sviluppo e prove, impianti radio e telefonici, abitazioni, hi-fi, computer e per efficiente e sicura protezione contro caduta fulmini.

Reliable and very efficient insulation transformers: built in cabinet, they include **electrostatic shield device to limit transient and transient noise limiters**. High protection against lightning damage, they eliminate voltage dispersion to ground in all electrical device connected, main noise filter.

**Features:** rough cabinet and compliant with current standards, input breaker, protected terminal block, innovative LCD display for viewing the load power and output voltage.

**Applications:** medical equipments, GSM - radio communications repeaters, development and metering laboratories, computers, switches and P.A.B.X., hi-fi and video equipments, homes etc.

GALVANIC SEPARATORS

MODELLO/MODEL	TSR 1000	TSR 2000	TSR 3000	TSR 4000	TSR 8000	
POTENZA POWER	80% duty cycle	1000VA	2000VA	3000VA	4000VA	8000VA
	100% duty cycle	800VA	1600VA	2400VA	3200VA	6400VA
RETE IN-OUT IN-OUT LINE	230Vac ±10% 50Hz					
STABILITÀ AL CARICO LOAD STABILITY	±3%					
ISOLAMENTO DIELETTICO INSULATION TEST	6kV test for 30"				8kV test for 30"	
SOPPRESSIONE TRANSITORI NOISE REJECTION	-60dB typ. at 5kHz					
DIMENSIONI LxPxH (mm) SIZE WxDxH (mm)	263 x 340 x 180		270 x 330 x 225		270 x 330 x 245	
PESO (Kg) WEIGHT (Kg)	20	27	30	31	57	
DISPLAY LCD COLOUR MULTIFUNCTION	✓	✓	/	/	/	
TEMPERATURA TEMPERATURE	-10°C +40°C utilizzo - environmental		-20°C +80°C immagazzinamento - storage			
UMIDITÀ RELATIVA HUMIDITY	max 85% non condensata - not condensate					
CONFORMITÀ CONFORMITY	CE EMC 2014/30/UE, LVD 2014/35/UE, RoHS					

### LCD DISPLAY

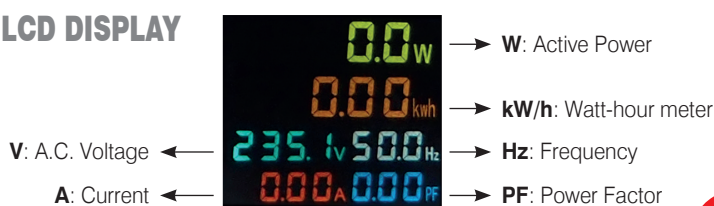

# TSR DIN BAR



## TRASFORMATORI SEPARATORI GALVANICI DI RETE GALVANIC SEPARATORS SAFETY TRANSFORMERS

Made in Italy



**TSR 270 270VA**  
**TSR 340 340VA**



**TSR 450 450VA**  
**TSR 900 900VA**

Affidabili ed efficienti trasformatori separatori galvanici "open frame" per installazione su barra DIN o parete all'interno di armadi.

**Sicura e valida protezione** contro le scariche atmosferiche, eliminano le dispersioni elettriche verso terra.

**Applicazioni:** particolarmente suggeriti per proteggere alimentatori switching sia nelle installazioni esterne, su pali stradali, su ponti ripetitori che in impianti industriali ed in zone ad alto rischio temporali.

- Salvano tempo, denaro e operatività
- La migliore protezione contro caduta fulmini
- Eliminano le dispersione elettriche verso terra
- Installazione da barra DIN

- Save money and time
- Great protection against lightning damage
- Ground leakage protection
- Din bar mounting



INGRESSO INQUINATO  
INPUT NOISE



USCITA FILTRATA  
OUTPUT FILTERING

Very reliable and useful "open frame" transformers din bar installation into cabinet.

**Safe and reliable protection against lightning damage**, eliminate the leakage to ground.

**Applications:** the best and efficient input protection of switching power supplies against lightning damage mostly for outdoor installation in high risk zones, radio links, industrial plants, etc.

MODELLO/MODEL	TSR 270	TSR 340	TSR 340-400	TSR 450	TSR 900	
POTENZA POWER	80% duty cycle	270VA	340VA	340VA	450VA	900VA
	100% duty cycle	215VA	275VA	275VA	360VA	765VA
RETE IN-OUT IN-OUT LINE	230Vac ±10%		400Vac ±10%	230Vac ±10%		
STABILITÀ AL CARICO LOAD STABILITY	±5%					
ISOLAMENTO DIELETTRICO INSULATION TEST	6kV test for 30"			3,5kV test for 30"		
CONNESSIONI CONNECTIONS	<ul style="list-style-type: none"> <li>• Morsetti isolati IN OUT - Insulated IN OUT terminal block</li> <li>• Clamp da barra DIN - DIN bar clamps</li> </ul>			<ul style="list-style-type: none"> <li>• Morsetti IN OUT - IN OUT terminal block</li> <li>• Clamp da barra DIN - DIN bar clamps</li> </ul>		
DIMENSIONI LxPxH(mm) SIZE WxDxH(mm)	80x115x100			75x164x165		
PESO (Kg) WEIGHT (Kg)	3	3,5	4	4,5	6	
TEMPERATURA TEMPERATURE	-10°C +40°C utilizzo - environmental			-20°C +80°C immagazzinamento - storage		
UMIDITÀ RELATIVA HUMIDITY	max 85% non condensata - not condensate					
CONFORMITÀ CONFORMITY	EMC 2014/30/UE, LVD 2014/35/UE, RoHS					

Applicazione tipica  
Typical application

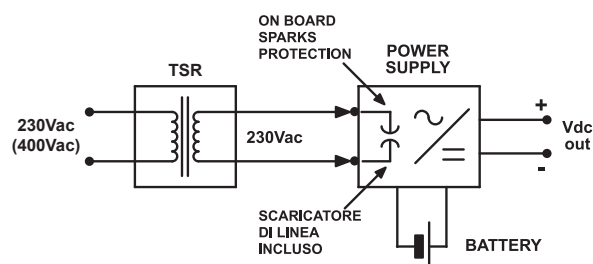

www.microset.net

GALVANIC SEPARATORS

# ESTAB 1PH



## STABILIZZATORI ELETTRONICI DI TENSIONE MONOFASE

### FULL ELECTRONIC VOLTAGE STABILIZERS - 1PH 230Vac

Made in Italy



ESTAB 1000C - 2500C - 4000C



ESTAB 8000

- Completamente automatici
- Assenza di manutenzione
- Ampio range di tensione
- Stabilizzazione in tempo reale
- Ottima precisione di uscita

- Full automatic solid state
- Maintenance free
- Wide input voltage range
- High speed regulation
- Excellent output stability

I migliori e più affidabili stabilizzatori di tensione sul mercato.

Eccellenti per stabilizzare la tensione di rete anche in presenza di forti instabilità, per applicazioni industriali, commerciali e domestiche, in zone densamente industrializzate, fine linea o in aree con carenza servizio.

**Caratteristiche:**

- completamente a stato solido con controllo digitale
- vita operativa illimitata
- assenza di manutenzione e di usura
- stabilizzazione in tempo reale
- ampio campo di regolazione d'ingresso
- ottima precisione d'uscita
- bassa distorsione armonica
- innovativo display LCD per immediata visualizzazione delle grandezze di uscita (potenza, tensione, corrente).

**Applicazioni:** macchine fotocopiatrici, computer, plotter, macchine automatiche, distributori carburanti, Hi-Fi, abitazioni, frigoriferi, condizionatori d'aria, impianti solari.

The most advanced and reliable A.C. Voltage stabilizers on the market.

Excellent voltage stabilizers family able to regulate very unstable main voltage condition, useful in commercial or civil applications, industrial parks, countryside or rural areas with bad line services.

**Features:**

- full solid state, digital control
- very long operative life
- maintenance free
- high-speed regulation
- wide input range regulations
- excellent output voltage stability
- low distortion THD
- new LCD display for easy verification of all output values (power, voltage, current)

**Applications:** photocopy machines, laser printers, computers, plotters, automations, distributors and automatic cash, petrol-pumps, Hi-Fi, houses, air conditioners, refrigerators, etc.

1PH STABILIZERS AVR

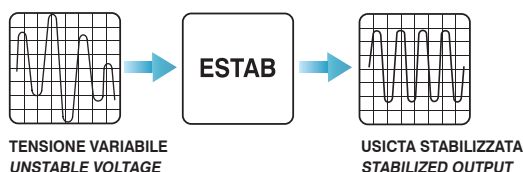

# ESTAB 1PH



## STABILIZZATORI ELETTRONICI DI TENSIONE MONOFASE

### FULL ELECTRONIC VOLTAGE STABILIZERS - 1PH 230Vac

Made in Italy

MODELLO/MODEL	ESTAB 1000C	ESTAB 2500C	ESTAB 4000C	ESTAB 8000
POTENZA APPLICABILE POWER RATING	1000VA	2500VA	4000VA	8000VA
<b>INGRESSO/INPUT</b>				
RANGE TENSIONE VOLTAGE RANGE	230Vac <b>-25% +20%</b> (172~276Vac)			
FREQUENZA FREQUENCY	50Hz			
CORRENTE CURRENT	4,5A	11A	18,2A	36A
<b>USCITA/OUTPUT</b>				
TENSIONE STABILIZZATA OUTPUT VOLTAGE	230Vac <b>±2,5%</b> (224÷235Vac)			
DISTORSIONE ARMONICA T.H.D.	<1%			
FATTORE DI POTENZA COSφ POWER FACTOR COSφ	0,95			
CARICO APPLICABILE AVAILABLE LOAD	0 - 100%			
EFFICIENZA EFFICIENCY	96% - 98%			
VELOCITÀ DI CONTROLLO CONTROL SPEED	1ms/V main synchronized			
SOVRACCARICO OVERLOAD	+ 20% for 1 minute			
PROTEZIONI PROTECTIONS	• Interruttore magnetotermico • Fusibile: in ingresso, rapido su P.C.B.		• Input breaker • Fuses: input side, rapid on P.C.B.	
<b>INSTALLAZIONE/INSTALLATION</b>				
DIMENSIONI LxPxH (mm) SIZE WxDxH (mm)	263 x 340 x 180	263 x 340 x 180	280 x 240 x 380	
PESO (Kg) WEIGHT (Kg)	10	18	22	29
DISPLAY LCD COLOUR MULTIFUNCTION	✓	✓	✓	/
CONNESSIONI IN-OUT IN-OUT CONNECTIONS	• Morsettiera protetta		• Protected terminal block	
CLASSE DI ISOLAMENTO INSULATION CLASS	DOUBLE INSULATION			
TEMPERATURA AMBIENTE ENVIRONMENTAL TEMPERATURE	-5°C +40°C			
UMIDITÀ RELATIVA HUMIDITY	max 85% non condensata - not condensate			
CONFORMITÀ CONFORMITY	EMC 2014/30/UE, LVD 2014/35/UE, RoHS			

1PH STABILIZERS AVR

# ESTAB-S



## CONDIZIONATORI DI RETE MONOFASE 230Vac

### A.C. LINE CONDITIONERS - 1 PH 230Vac

Made in Italy



#### ESTAB 1000SC

Condizionatori di rete elettronici con caratteristiche altamente professionali e prestazioni eccellenti: stabilizzano, separano e filtrano la tensione di rete, proteggono l'apparato alimentato con ottima efficienza.

Includono due sezioni e doppie funzioni:

- **trasformatore separatore galvanico** di sicurezza per protezione contro caduta fulmini e per eliminare disturbi ed interferenze di linea, con isolamento della rete sollevando il neutro dalla massa.
- **stabilizzatore di tensione elettronico** a stato solido con elevata velocità di controllo, ampio campo di regolazione e ottima precisione e regolazione d'uscita.

#### Caratteristiche:

- **assenza totale di usura, oltre 10 anni senza manutenzione,**
- innovativo display LCD per immediata visualizzazione delle grandezze di uscita (potenza, tensione, corrente)
- scaricatore a gas anti fulmine incluso
- trasformatore con elevata rigidità dielettrica
- stabilizzazione in tempo reale
- bassa distorsione armonica

È possibile ottenere condizionatori di tensione di potenza maggiorata oltre i 2kVA, combinando in serie trasformatore TSR e unità stabilizzatrice ESTAB:

- 4kVA → TSR 4000 + ESTAB 4000
- 8kVA → TSR 8000 + ESTAB 8000

Applicazioni: elettromedicali, computer-server, distributori automatici e di carburante, automazione industriale, laboratori di ricerca e sviluppo, complessi musicali, impianti Hi-Fi, ponti e sale radio, centralini telefonici, fotocopiatrici, abitazioni, ecc.

- Doppia protezione: stabilizzano la tensione e filtrano i disturbi di rete
- Protezione anti fulmine
- Completamente automatici
- Oltre 10 anni senza manutenzione

- **Double protection: voltage stabilization and noise filtering**
- **Lightning damage protection**
- **Full automatic solid state**
- **Over 10 years maintenance free**

Professional A.C. stabilizers line conditioners, excellent performances: AVR with galvanic separation to obtain stabilized and filtered output for the best load protection.

Two main functions:

- **high insulation galvanic transformer** for safety, provided with spark gas protectors **against lightning damage**, noise voltage filter, floating mains neutral.
- **electronic voltage stabilizer**, full solid state, high resolution, fast recovery, wide range voltage regulation, out voltage accuracy.

#### Features:

- **long life, more than 10 years free maintenance**
- new LCD display for easy verification of all output values (power, voltage, current)
- gas voltage limiter included
- high insulation transformer
- high speed voltage regulation
- low harmonic distortion

Powerful A.C. line conditioners (with power over 2kVA) available by series connection of TSR galvanic separator unit and ESTAB AVR unit:

- 4kVA → TSR 4000 + ESTAB 4000
- 8kVA → TSR 8000 + ESTAB 8000

Applications: medical equipments, computer-server, automatic distributors petrol-pump, automations, research and development laboratories, musical and instrument studios, links, radio stations, photocopy machine, houses, etc.

1PH LINE CONDITIONERS



TENSIONE DI RETE INQUINATA  
NOISE AND DISTORTION

USCITA STABILIZZATA, FILTRATA E ISOLATA DALL'INGRESSO  
STABILIZED AND FILTERED OUTPUT WITH GALVANIC INSULATION



#### LCD DISPLAY

W: Active Power  
kWh: Watt-hour meter  
Hz: Frequency  
PF: Power Factor

V: A.C. Voltage  
A: Current

**ESTAB-S****CONDIZIONATORI DI RETE MONOFASE 230Vac****A.C. LINE CONDITIONERS - 1 PH 230Vac**

Made in Italy

MODELLO/MODEL	ESTAB 1000-SC	ESTAB 2000-SC
POTENZA APPLICABILE POWER RATING	1000VA	2000VA
<b>INGRESSO/INPUT</b>		
RANGE TENSIONE VOLTAGE RANGE	230Vac <b>-25% +20%</b> (172~276Vac)	
FREQUENZA FREQUENCY	50Hz	
CORRENTE CURRENT	4,5A	11A
<b>USCITA/OUTPUT</b>		
TENSIONE STABILIZZATA OUTPUT VOLTAGE	230Vac <b>±2,5%</b> (224÷235Vac)	
DISTORSIONE ARMONICA T.H.D.	<1%	
FATTORE DI POTENZA COSφ POWER FACTOR COSφ	0,95	
CARICO APPLICABILE AVAILABLE LOAD	0 - 100%	
EFFICIENZA EFFICIENCY	> 96%	
VELOCITÀ DI CONTROLLO CONTROL SPEED	1ms/V main synchronized	
ISOLAMENTO GALVANICO GALVANIC INSULATION	6kV test 30"	
ATTENUAZIONE IN-OUT NOISE REJECTION	F.I. 5kHz - 50dB	
SOVRACCARICO OVERLOAD	+ 20% for 1 minute	
PROTEZIONI PROTECTIONS	<ul style="list-style-type: none"> <li>• Interruttore magnetotermico</li> <li>• Fusibile: in ingresso, rapido su P.C.B.</li> <li>• Scaricatore antifulmine</li> </ul>	<ul style="list-style-type: none"> <li>• <i>Input breaker</i></li> <li>• <i>Fuses: input side, rapid on P.C.B.</i></li> <li>• <i>Spark gas voltage limiters</i></li> </ul>
<b>INSTALLAZIONE/INSTALLATION</b>		
DIMENSIONI LxPxH (mm) SIZE WxDxH (mm)	263 x 340 x 180	
PESO (Kg) WEIGHT (Kg)	21	26
CONNESSIONI IN-OUT IN-OUT CONNECTIONS	• Morsettiera protetta	• <i>Protected terminal block</i>
CLASSE DI ISOLAMENTO INSULATION CLASS	 DOUBLE INSULATION	
TEMPERATURA AMBIENTE ENVIRONMENTAL TEMPERATURE	-5°C +40°C	
UMIDITÀ RELATIVA HUMIDITY	max 85% non condensata - <i>not condensate</i>	
CONFORMITÀ CONFORMITY	 EMC 2014/30/UE, LVD 2014/35/UE, RoHS	

1PH LINE CONDITIONERS

## 3 ESTAB



## STABILIZZATORI DI TENSIONE TRIFASE ELETTRONICI 3PH+N 3-PHASES+N VOLTAGE STABILIZERS - FULL ELECTRONIC

Made in Italy



**3 ESTAB**  
DIGITAL CONTROL



**3 ESTAB 8000 RACK**

- Completamente automatici
- Ampio range di tensione
- Operatività illimitata
- Stabilizzazione a fasi indipendenti

- Full automatic solid state
- Wide input voltage range
- Always operative - maintenance free
- Independent phase control

Robusti ed affidabili stabilizzatori di tensione trifase elettronici stato solido senza manutenzione privi di parti in movimento, molto efficaci anche in presenza di forti instabilità di rete.

Disponibili in due configurazioni:

- **3 ESTAB: soluzione efficiente e più economica**, fisicamente composti da **tre unità stabilizzatrici ESTAB-1PH** (da disporre uno sopra l'altro o affiancate) e **assemblate** tra loro **con box di cablaggio**.
- **3 ESTAB RACK: versione completa di armadio 19U rack 19"** di contenimento delle tre unità stabilizzatrici monofase, completo di strumenti voltmetro/wattmetro di ingresso e di uscita.

### Caratteristiche comuni:

- media potenza, 12kVA e 24kVA
- **totalmente elettronici a stato solido con controllo digitale**
- **stabilizzazione di ogni singola fase in modo indipendente:** consente di equilibrare le 3 fasi anche in presenza di carico molto sbilanciato
- regolazione in tempo reale
- ampio range di tensione di ingresso: particolarmente adatti per zone industriali e periferiche soggette a frequenti sbalzi di rete
- **operatività illimitata:** oltre 10 anni senza alcuna manutenzione, nessuna parte meccanica in movimento

**Applicazioni: macchine a controllo automatico, laboratori test e controllo, sistemi di sicurezza e allarmi, ecc.**

**Full solid state electronics three phases automatic A.C. voltage stabilizers very efficient also on large instability voltage maintenance free.**

Available two versions:

- **3 ESTAB: cheaper but reliable version**, built-up by **3 single monophase ESTAB stabilizer units, connected together with wiring box** and assembled each up to the other or each besides the other
- **3 ESTAB RACK: wired version in cabinet 19 unit rack 19"**, including the three single monophase stabilizers and input/output voltage-wattmeter.

### Common features:

- medium power, 12kVA - 24kVA
- **full solid state and digital control**
- **independent phase control:** the system gives a perfect voltage stability also with unbalanced load
- high regulation speed
- wide input voltage range: useful and suitable in critical applications as industrial parks and countryside or rural zones with bad line service
- **very long operative life:** over 10 years maintenance free, no mechanical parts

**Applications: industrial automation and tool machinery, test laboratories, safety and alarms plants, etc.**

# 3 ESTAB



## STABILIZZATORI DI TENSIONE TRIFASE ELETTRONICI 3PH+N 3-PHASES+N VOLTAGE STABILIZERS - FULL ELECTRONIC

Made in Italy

MODELLO/MODEL	3 ESTAB 2500	3 ESTAB 4000	3 ESTAB 4000 RACK	3 ESTAB 8000	3 ESTAB 8000 RACK
POTENZA APPLICABILE POWER RATING	7,5kVA	12kVA		24kVA	
<b>INGRESSO/INPUT</b>					
RANGE TENSIONE VOLTAGE RANGE	400Vac <b>-25% +20%</b> (3PH+N)				
FREQUENZA FREQUENCY	50-60Hz $\pm 5\%$				
CORRENTE CURRENT	11A (12A max on single phase)	18A (20A max on single phase)		36A (40A max on single phase)	
<b>USCITA/OUTPUT</b>					
TENSIONE STABILIZZATA OUTPUT VOLTAGE	400Vac $\pm 2,5\%$ (3PH+N)				
DISTORSIONE ARMONICA T.H.D.	2% typ.				
FATTORE DI POTENZA $\cos\phi$ POWER FACTOR $\cos\phi$	0,95				
CARICO APPLICABILE AVAILABLE LOAD	0 - 100%				
EFFICIENZA EFFICIENCY	> 96%				
VELOCITÀ DI CONTROLLO CONTROL SPEED	1ms/V main synchronized				
CONTROLLO CONTROL MODE	a fasi indipendenti independent phase				
SOVRACCARICO OVERLOAD	+ 20% for 1 minute				
PROTEZIONI PROTECTIONS	<ul style="list-style-type: none"> <li>• Interruttore magnetotermico generale</li> <li>• N° 2 fusibili su P.C.B. di ciascuna unità</li> </ul>		<ul style="list-style-type: none"> <li>• Input main breaker</li> <li>• N° 2 fuses on P.C.B. of each stabilizer unit</li> </ul>		
<b>INSTALLAZIONE/INSTALLATION</b>					
DIMENSIONI LxPxH (mm) SIZE WxDxH (mm)	230x315x720	310x240x720	530x450x1040	240x840x380	530x450x1040
PESO (Kg) WEIGHT (kg)	54	67	70	88	95
SEGNALAZIONI SIGNALLING	Display LCD multifunction	Display LCD multifunction	Watt meter IN-OUT	/	Watt meter IN-OUT
CONNESSIONI IN-OUT IN-OUT CONNECTIONS	connection box	connection box	morsettiera terminal block	connection box	morsettiera terminal block
CLASSE DI ISOLAMENTO INSULATION CLASS	DOUBLE INSULATION				
TEMPERATURA AMBIENTE ENVIRONMENTAL TEMPERATURE	-5°C +40°C				
UMIDITÀ RELATIVA HUMIDITY	max 85% non condensata - not condensate				
CONFORMITÀ CONFORMITY	EMC 2014/30/UE, LVD 2014/35/UE, RoHS				

STABILIZERS 3PH

# BST



## STABILIZZATORI DI TENSIONE ELETTROMECCANICI 3PH+N 3PH+N ELECTRO MECHANICAL VOLTAGE STABILIZERS

Made in Italy



BST

- Ottima efficienza >98%
- Controllo medio, opzionale su fasi indipendenti
- Elevata precisione di uscita
- Buona immunità alle scariche elettrostatiche

- Very high efficiency >98%
- Average control, optional independent phase control
- Excellent output regulation
- Good immunity against electrostatic leakage

**Affidabili stabilizzatori di tensione di grossa potenza**, con regolatore elettromeccanico che conferisce robustezza e buona immunità alle scariche elettrostatiche e fulmini in rete. Da configurazione standard presenta controllore elettronico nella media delle tre fasi.

In presenza di carichi molto sbilanciati è possibile fornire la **versione -IR con regolazione su fasi indipendenti**, con kit "full protection" di protezione alle sovracorrenti in uscita e relè di remote control (optional).

### Caratteristiche:

- protezione contro gli spunti motore
- ampio range di tensione di ingresso:
  - standard:**  $\pm 15\%$  con 1,5% precisione di uscita
  - su richiesta:**  $\pm 20\%$  con 2,5% precisione di uscita
- immunità alle variazioni di frequenza 47~63Hz
- minima distorsione armonica

**Reliable big size voltage stabilizers** equipped with analog electronic control and electromechanical regulator, rugged lightning protection. Standard configuration in operating on operating on phases average control.

With very unbalanced load it is possible to provide **-IR version** with static control and **independent phase regulation**, with optional "full protection kit" (output overcurrent protection and monitoring relay).

### Features:

- surge protection
- wide input voltage range:
  - standard:** in  $\pm 15\%$ , out regulation  $\pm 1,5\%$
  - on request:** in  $\pm 20\%$ , out regulation  $\pm 2,5\%$
- immunity to frequency variation from 47 to 63Hz
- negligible THD

STABILIZERS 3PH

### AVERAGE CONTROL

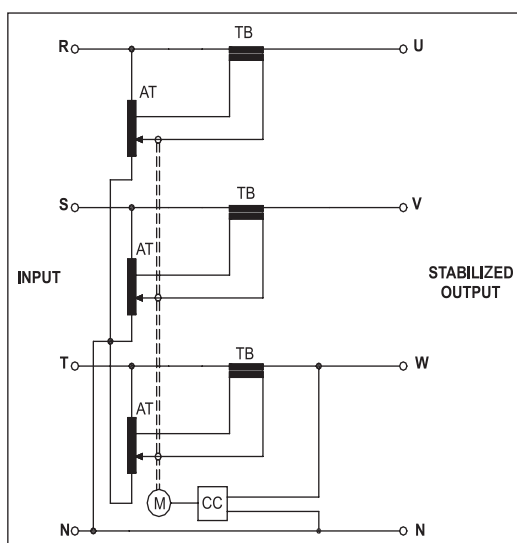

### IR - INDEPENDENT REGULATION

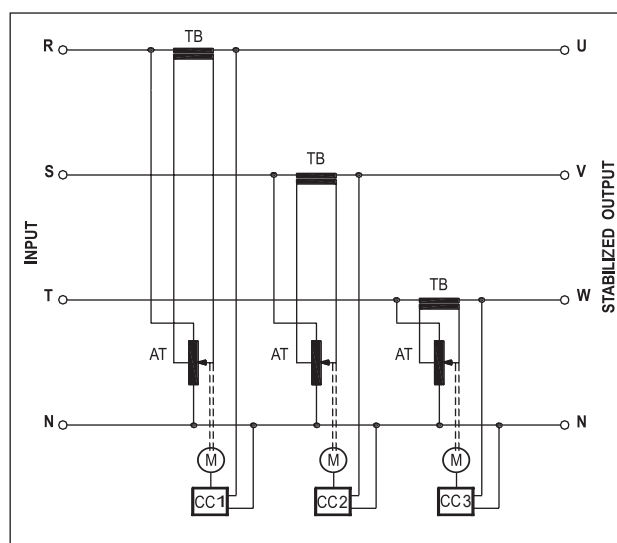

**BST****STABILIZZATORI DI TENSIONE ELETTROMECCANICI 3PH+N**  
**3PH+N ELECTRO MECHANICAL VOLTAGE STABILIZERS**

Made in Italy

MODELLO/MODEL	BST T 45	BST T 60	BST T 90	BST T 110	BST T 150
POTENZA APPLICABILE POWER RATING	45kVA	60kVA	90kVA	90kVA	150kVA
<b>INGRESSO/INPUT</b>					
RANGE TENSIONE VOLTAGE RANGE	400Vac $\pm 15\%$ (3PH+N) (340~460Vac)				
FREQUENZA FREQUENCY	50-60Hz $\pm 5\%$ (48~63Hz)				
CORRENTE CURRENT	76A	102A	153A	187A	255A
<b>USCITA/OUTPUT</b>					
TENSIONE STABILIZZATA OUTPUT VOLTAGE	400Vac $\pm 2,5\%$ (standard) " $\pm 1,5\%$ (-IR optional)				
FATTORE DI POTENZA $\cos\phi$ POWER FACTOR $\cos\phi$	0,95				
CARICO APPLICABILE AVAILABLE LOAD	+ 300% for 2 minutes + 150% for 10 minutes				
EFFICIENZA EFFICIENCY	>98%				
DISTORSIONE ARMONICA T.H.D.	<0,5%				
VELOCITÀ DI CONTROLLO CONTROL SPEED	13÷35ms/V				
CONTROLLO CONTROL MODE	stabilizzazione media - <i>average stabilization</i> Optional: -IR version stabilizzazione su singola fase - <i>independent phase stabilization</i>				
PROTEZIONI PROTECTIONS	<ul style="list-style-type: none"> <li>• Interruttore magnetotermico</li> <li>• SLC surge protection</li> </ul>		<ul style="list-style-type: none"> <li>• <i>Input breaker</i></li> <li>• <i>SLC surge protection</i></li> </ul>		
PROTEZIONI OPZIONALI OPTIONAL PROTECTIONS	<ul style="list-style-type: none"> <li>• al sovraccarico in uscita</li> </ul>		<ul style="list-style-type: none"> <li>• <i>overcurrent protector</i></li> </ul>		
<b>INSTALLAZIONE/INSTALLATION</b>					
DIMENSIONI mm LxPxH (mm) SIZE mm WxDxH (mm)	600x600x1200	600x600x1500		600x600x1800	
PESO (Kg) WEIGHT (Kg)	210	265	290	460	580
SEGNALAZIONI SIGNALLING	<ul style="list-style-type: none"> <li>• LED presenza rete (singola fase)</li> <li>• Multimetro digitale multifunzione</li> </ul>		<ul style="list-style-type: none"> <li>• <i>LED main on (single phase)</i></li> <li>• <i>Digital multimeter</i></li> </ul>		
TEMPERATURA AMBIENTE ENVIRONMENTAL TEMPERATURE	-20°C +45°C				
UMIDITÀ RELATIVA HUMIDITY	max 95% non condensata - <i>not condensate</i>				
CONFORMITÀ CONFORMITY	EMC 2014/30/UE, LVD 2014/35/UE, RoHS				

STABILIZERS 3PH

## OTHER PRODUCTS



## GRUPPI DI CONTINUITÀ - SOCCORRITORI NO BREAK

### U.P.S. - NO BREAK EMERGENCY UNITS



PMT

#### U.P.S. 1PH 230Vac

**On-line double conversion**  
**AVR voltage stabilization  $\pm 15\%$**   
**Onda sinusoidale - true sine waveform**

- **PMT**  
Power: 1kVA - 2kVA - 3kVA - 6kVA - 10kVA  
Tower configuration
- **PMT PLUS**  
Version with extra battery cabinet



PMR-RT



- **PMR-RT**  
Power: 1kVA - 2kVA - 3kVA - 6kVA  
Rack 19" plug-in or tower convertible  
Battery expandable

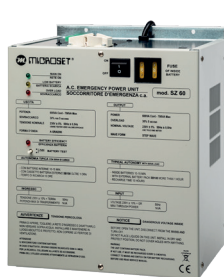

SZ



SXT-S

#### U.P.S. EMERGENCY UNITS 1PH 230Vac

**Line interactive**  
**AVR voltage stabilization  $\pm 10\%$**   
**Large autonomy**

- **SXT-S**  
Power: 2kVA - 3kVA  
Pure sine waveform
- **SZ**  
Power: 600VA - 1500VA - 2500VA  
Step waveform  
SB expandable battery pack

#### U.P.S. 3PH - INDUSTRIAL USE

**On-line double conversion**  
**Booster PFC**  
**Pure sine waveform**  
**H24 service**

- **MTT**  
Power: 10kVA - 100kVA  
IN 3PH+N  
OUT 3PH
- **MTM**  
Power: 10kVA - 100kVA  
IN 3PH+N  
OUT 1PH 230Vac

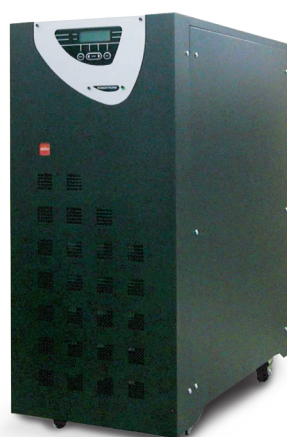

MTM - MTT

Ampia gamma di modelli e autonomia.  
Wide range power, size and autonomy.





I DATI E SPECIFICHE SONO INDICATIVI E POSSONO VARIARE SENZA PREAVVISO. TUTTI I DIRITTI RISERVATI.  
*SPECIFICATIONS COULD CHANGE WITHOUT NOTICE. ALL RIGHT RESERVED.*



Via A. Peruch, 64 - 33077 Sacile (PORDENONE) - Italy  
Tel. (+39) 0434 72459 - Fax. (+39) 0434 72450  
info@microset.net - www.microset.net

